

BR24L32-W/F-W/FJ-W/FV-W BR24L64-W/F-W

Features

- 32k bit serial EEPROM organized as 4k × 8bit (BR24L32)
64k bit serial EEPROM organized as 8k × 8bit (BR24L64)
- 2 wire bus serial interface (2 byte Address)
- Low operating voltage range (2V operating)
Read : 1.8~5.5V
Write : 1.8~5.5V
- Low current consumption
Active : 3mA MAX
Standby : 2μA MAX
- Clock frequency : 100kHz MAX (1.8~5.5V)
400kHz MAX (2.5~5.5V)
- Write cycle time : 5ms MAX
- Address auto-increment function during read operation
- Automatic erase-before-write function during write operation
- Page write function : 32byte
- Inadvertent write protection function
Inadvertent write protection at low voltage (Vcc Lock-out function)
WP (Write Protect) function
- Schmitt trigger circuit and noise filter are built into SCL and SDA pins
- 1,000,000 write cycle typical
- 40 years data retention
- Operating temperature range : -40~85°C

Pin Configurations

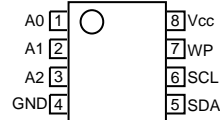

DIP8/SOP8/SOP-J8*/SSOP-B8

DIP8/SOP8 (Only BR24L64)

Pin Functions

Pin Names	Functions
A0, A1, A2	Slave Address Inputs
GND	Ground
SDA	Serial Data Input/Output
SCL	Serial Data Clock
WP	Write Protect
Vcc	Power Supply

* Under development

Block Diagram

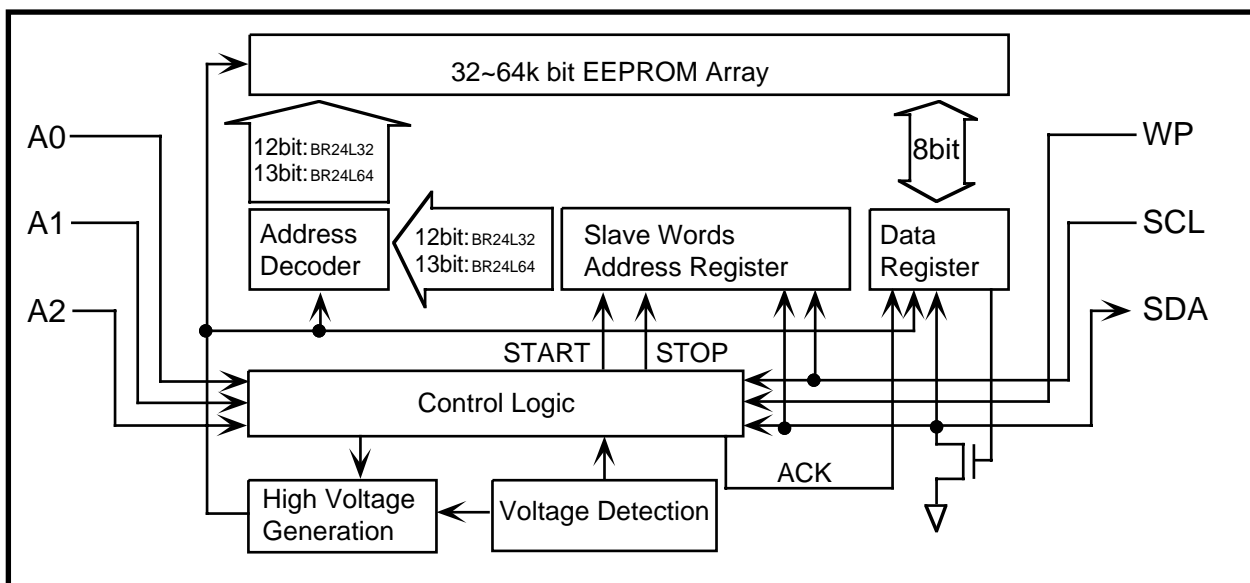

**ROHM EEPROM
1.8V Low Voltage
operating**

**ROHM EEPROM
1,000,000
Write cycle**

**ROHM EEPROM
Double Cell**

Serial 2 Wire Interface (I²C BUS Type)

Timing chart

■ Byte write cycle

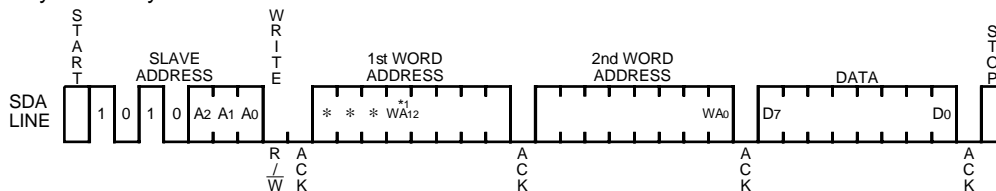

■ Page write cycle

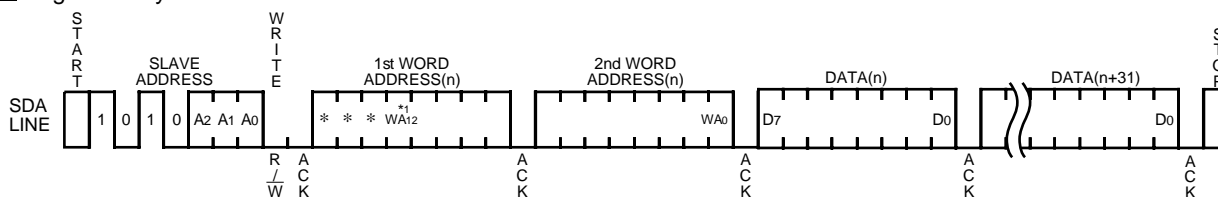

■ Current read cycle

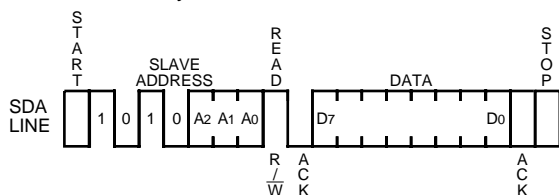

■ Random read cycle

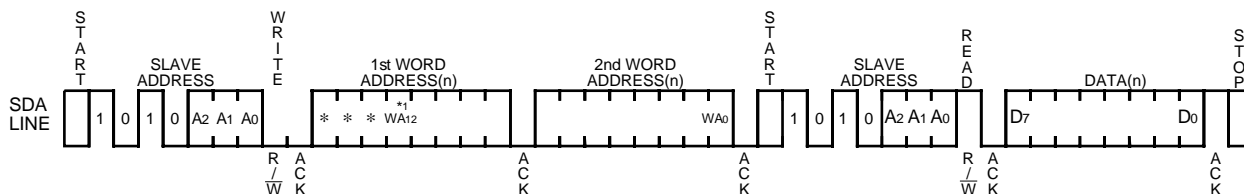

■ Sequential read cycle

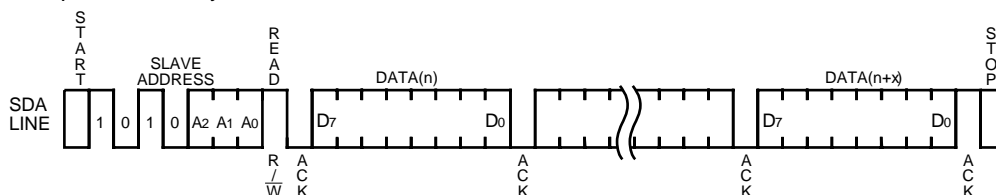

*1: WA12...Don't Care (BR24L32)

Note : BR24C32/F has no letter "-W", but it is a double-cell type.

BR24C64/F is a single-cell type.

Please be careful not to confuse w-cell type and single-cell type. ("-W" means double-cell type.)